



2-year warranty

Type overview

Type	DN
ZONE315N-35	15

Technical data

Functional data	Valve size [mm]	0.5" [15]
	Fluid	chilled or hot water, up to 50% glycol
	Fluid Temp Range (water)	32...212°F [0...100°C]
	Body Pressure Rating	300 psi
	Close-off pressure Δps	30 psi
	Flow characteristic	on/off, diverting
	Flow Pattern	3-way
	Leakage rate	ANSI Class III 0.1%
	Cv	3.5
Materials	Valve body	forged brass
	Housing seal	EPDM
	Stem	stainless steel
	Seat	EPDM
	Pipe connection	NPT
Suitable actuators	Spring	ZONE

Product features

Application This valve is typically used on fan coil units, baseboards or other hydronic applications where fail safe operation on 2-wire control is required. This valve is suitable for use in a hydronic system with variable or constant flow.

This valve is designed to fit in compact areas where on/off or control is required using 24 VAC or 120 VAC.

Dimensions

Type	DN	Weight
ZONE315N-35	15	1.1 lb [0.50 kg]

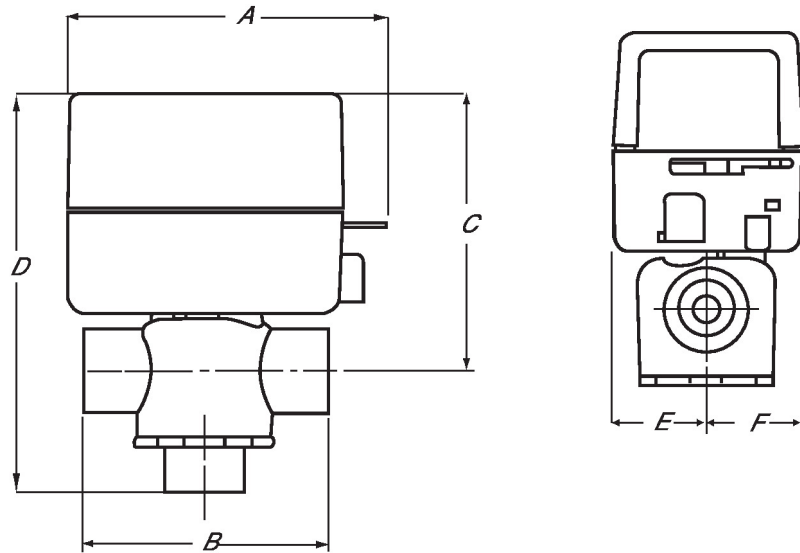

A	B	C	D	E	F
4.0" [102]	2.8" [70]	3.5" [89]	4.8" [122]	1.2" [30]	1.2" [31]